



2-6



6



0,6m



1 = 3,2m 2 = 0,75m 3 = 2m



Motor disability



Sensorial disabilities

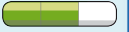

Learning disabilities

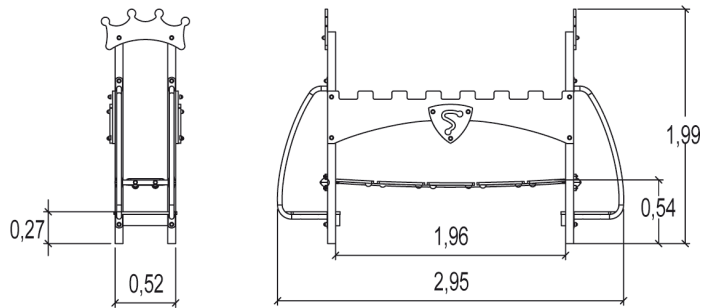
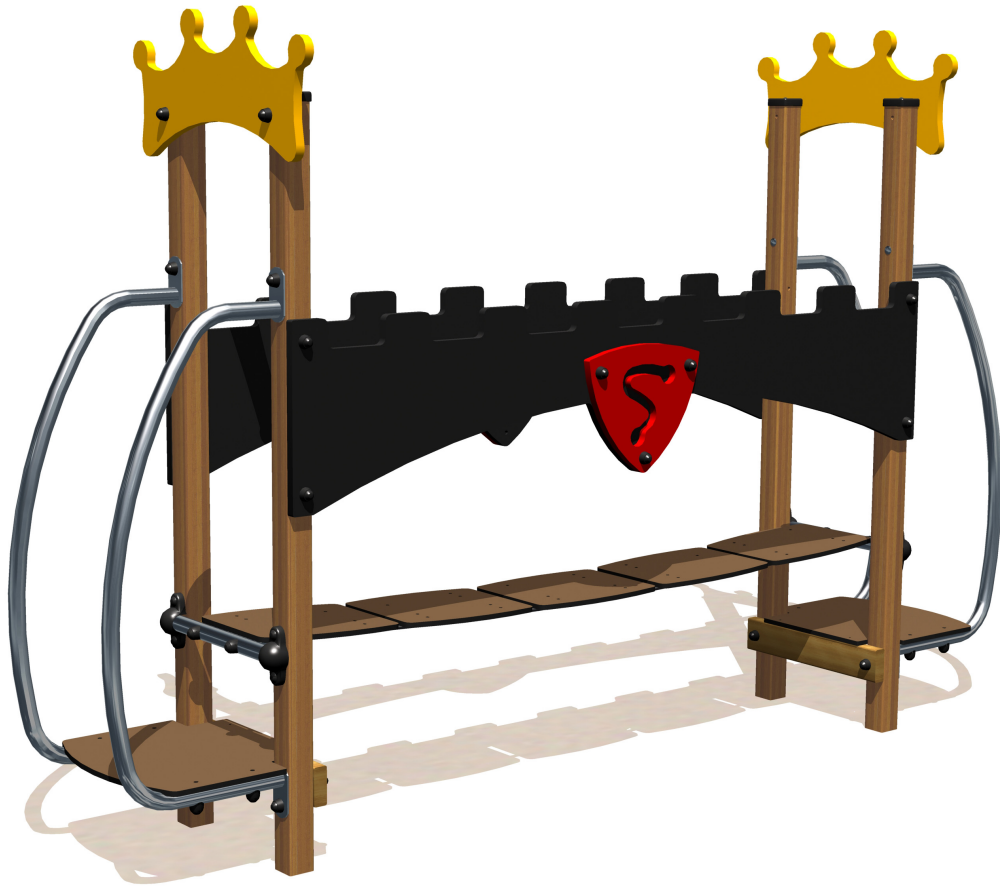

Play value : 3

role play



getting across



meeting



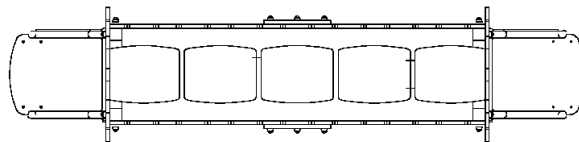







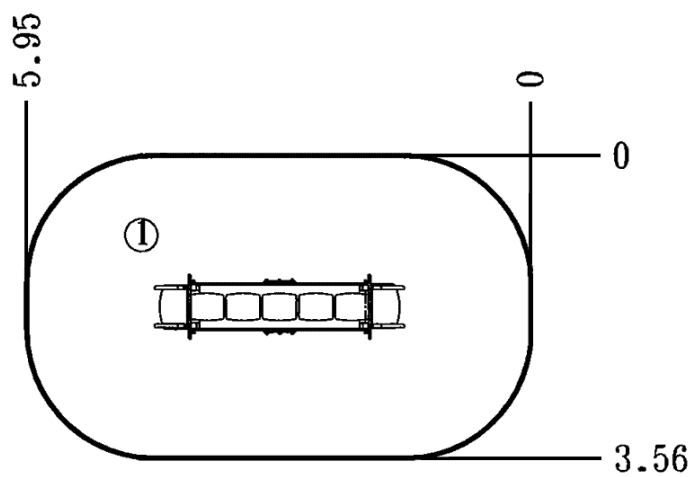



Installation of equipment

Impact area =

-  Impact area
-  Free space

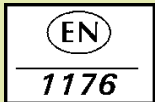

		
1	0,6m	21m ²

							
2	03h00	0.1m ³	21m ²	105kg	21kg		2012-11-09